



LAWRENCE
LIVERMORE
NATIONAL
LABORATORY

UCRL-ID-155446

Distributed Feedback Fiber Laser The Heart of the National Ignition Facility

Donald F. Browning, Gaylen V. Erbert

December 1, 2003

DISCLAIMER

This document was prepared as an account of work sponsored by an agency of the United States Government. Neither the United States Government nor the University of California nor any of their employees, makes any warranty, express or implied, or assumes any legal liability or responsibility for the accuracy, completeness, or usefulness of any information, apparatus, product, or process disclosed, or represents that its use would not infringe privately owned rights. Reference herein to any specific commercial product, process, or service by trade name, trademark, manufacturer, or otherwise, does not necessarily constitute or imply its endorsement, recommendation, or favoring by the United States Government or the University of California. The views and opinions of authors expressed herein do not necessarily state or reflect those of the United States Government or the University of California, and shall not be used for advertising or product endorsement purposes.

This is a preprint of a paper intended for publication in a journal or proceedings. Since changes may be made before publication, this preprint is made available with the understanding that it will not be cited or reproduced without the permission of the author.

This report has been reproduced
directly from the best available copy.

Available to DOE and DOE contractors from the
Office of Scientific and Technical Information
P.O. Box 62, Oak Ridge, TN 37831
Prices available from (423) 576-8401
<http://apollo.osti.gov/bridge/>

Available to the public from the
National Technical Information Service
U.S. Department of Commerce
5285 Port Royal Rd.,
Springfield, VA 22161
<http://www.ntis.gov/>

OR

Lawrence Livermore National Laboratory
Technical Information Department's Digital Library
<http://www.llnl.gov/tid/Library.html>

The National Ignition Facility Master Oscillator

DFB Fiber Laser “The Heart of the National Ignition Facility”

The National Ignition Facility (NIF) is a world-class laser fusion machine that is currently under construction at Lawrence Livermore National Laboratory (LLNL). The 192 laser beams that converge on the target at the output of the NIF laser system originate from a low power fiber laser in the Master Oscillator Room (MOR). The MOR is responsible for generating the single pulse that seeds the entire NIF laser system. This single pulse is phase-modulated to add bandwidth, and then amplified and split into 48 separate beam lines all in single-mode polarizing fiber. Before leaving the MOR, each of the 48 output beams are temporally sculpted into high contrast shapes using Arbitrary Waveform Generators. The 48 output beams of the MOR are amplified in the Pre-amplifier Modules (PAMs), split and amplified again to generate 192 laser beams. The 192 laser beams are frequency converted to the third harmonic and then focused at the center of a 10-meter diameter target chamber. The MOR is an all fiber-based system utilizing highly reliable Telecom-Industry type hardware. The nearly 2,000,000 joules of energy at the output of the NIF laser system starts from a single fiber oscillator that fits in the palm of your hand.

This paper describes the design and performance of the laser source that provides the precision light to the National Ignition Facility. Shown below is a simplified diagram illustrating the MOR's basic functions.

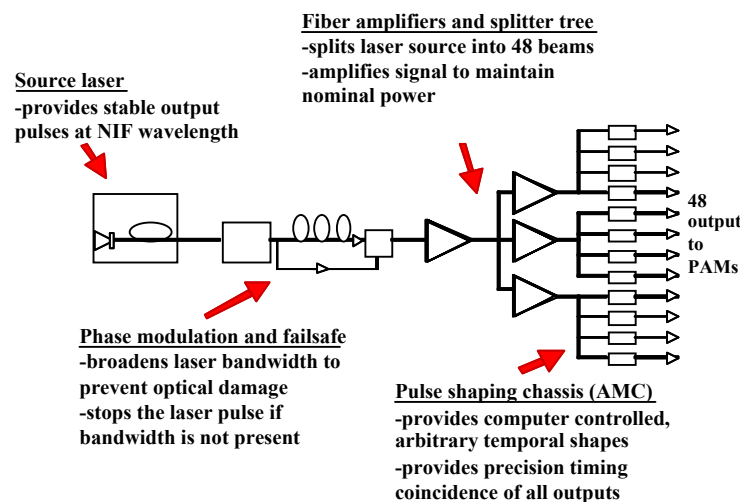

Figure 1 Master Oscillator Fiber System Basic Functions

Oscillator Design

The oscillator is a distributed feedback (DFB) fiber laser, made by imprinting linear Bragg gratings in a 2.8-micron rare earth Ytterbium (Yb) doped Silica fiber core using UV light. This technology is similar to that used in Er-doped fiber lasers for communications. The Bragg gratings form distributed reflectors that define the laser cavity and allow only one cavity mode to lase. The oscillator produces up to 20mW of CW power in a single longitudinal mode when pumped with 130 mW from a 980 nm laser diode. The master oscillator wavelength is precisely tuned to within 0.01 nm of the desired value of 1053.01nm by temperature-controlling its mount, which changes the Bragg wavelength by strain and the thermo-optic effect. The laser cavity temperature tuning coefficient is ~ 0.25 angstroms per degree C, and is designed to operate at ~ 25 degrees C.

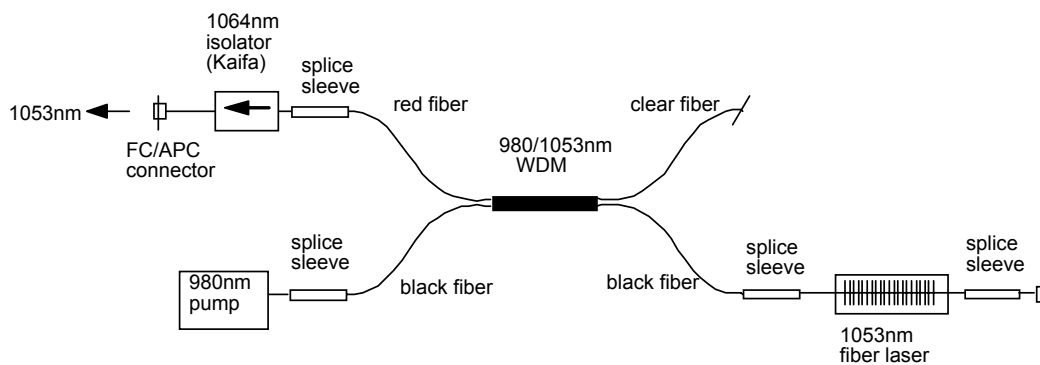

Figure 2 shows a schematic of the fiber master oscillator circuit.

The company Koheras Inc located in Denmark manufactures the custom laser circuit to the NIF specifications. Koheras is a spin-off company from Ionas A/S that specializes in design and production of narrow linewidth fiber lasers. Koheras has supported the NIF project in the development of a custom 1053nm laser circuit design over the last several years. The results of this work have produced an optimized laser design that meets the stringent NIF requirements for robust singlemode operation and wavelength & power stability. Koheras delivers the fiber laser circuit fusion spliced together and ready for integration into our custom chassis design. Figure 3 is a list of laser specifications.

NIF Master Oscillator Specifications

Laser Material	Yb:silica
Operating Wavelength	1053.0nm +/-0.1nm @ 25 degrees C
Wavelength Control	25pm/K +/-5pm/K
Output Power	>20mW (13dBm)
Longitudinal Mode	Single mode, without mode hopping over an 8 hour period
Pump Source	980nm, FBG stabilized, \geq 130mW operating power
Average output power variation	<2% RMS (8 hours)
Instantaneous Output Power variation	<1% p-p (8 hours) and relaxation oscillation peak amplitude <10dB above detector noise floor
Back reflection sensitivity	Unaltered performance with up to -40dB of output back reflection
Wavelength stability	Within 1053.0 +/-0.1nm for 1 year for temperatures within operating temperatures.
SNR	> 65dB(measured at full output power and 50pm resolution)
Linewidth	<500kHz

Figure 3 NIF 1053nm DFB Fiber laser specifications

The laser cavity is stretch-tuned & glued into an aluminum housing at the vendor. The custom housing is designed to integrate to our thermoelectric cooler and controller that provides precision temperature control for wavelength tuning.

The laser circuit is made of singlemode fiber and must be managed to reduce mechanical & temperature induced polarization drift of the output signal. Custom fiber spools are utilized to control the coils of fiber mounted to a standard 3/4-inch thick breadboard. The breadboard circuit is acoustically isolated with rubber standoffs and surrounded by sealed thermal foam. A manual polarization controller is used to correct the signal polarization errors from the singlemode fiber section to custom polarizing fiber (PZ) used to interconnect the system chassis. The polarization controller is an all-fiber squeezer type device that creates stress birefringence by applying force on the fiber. Figure 4 shows a picture of the fiber oscillator chassis optics and electronics bays.

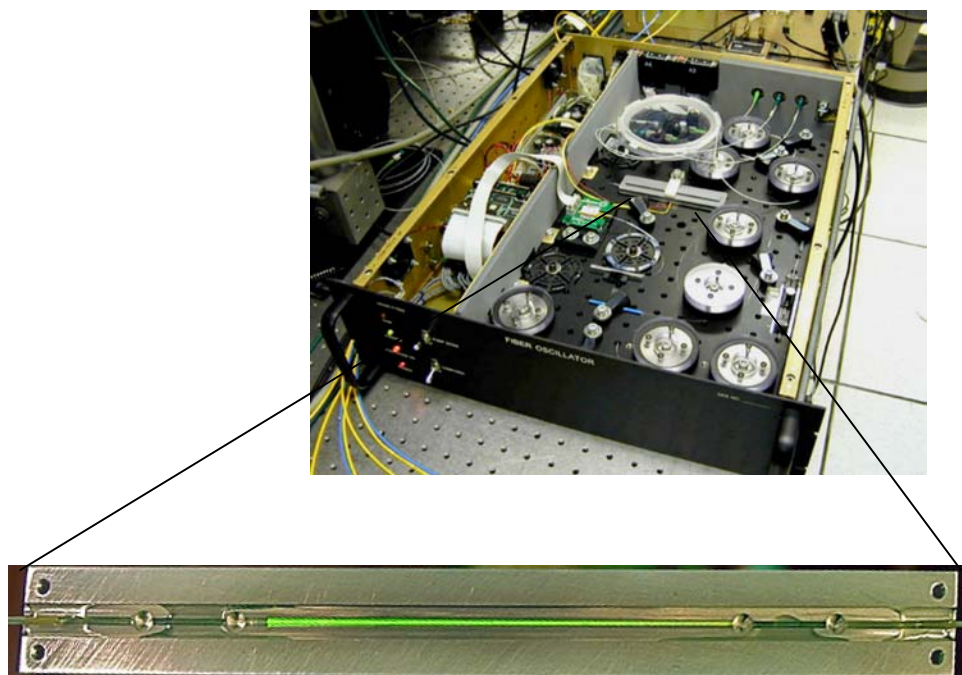

Figure 4 Photo of Master Oscillator Chassis design & photo of exposed view of end-pumped DFB fiber laser

The electronics bay design includes the power supplies and thermo-electric cooler controllers for the laser cavity and pump diode. An imbedded controller connected to the NIF Integrated Controls System via Ethernet monitors the control temperatures and pump diode power

Laser Performance

The performance of the oscillator is verified with a battery of characterization tests prior to integration in the main operating system including wavelength and power stability vs temperature, signal to noise, and singlemode operation. Figure 5 shows a general layout of diagnostics used to characterize the oscillator.

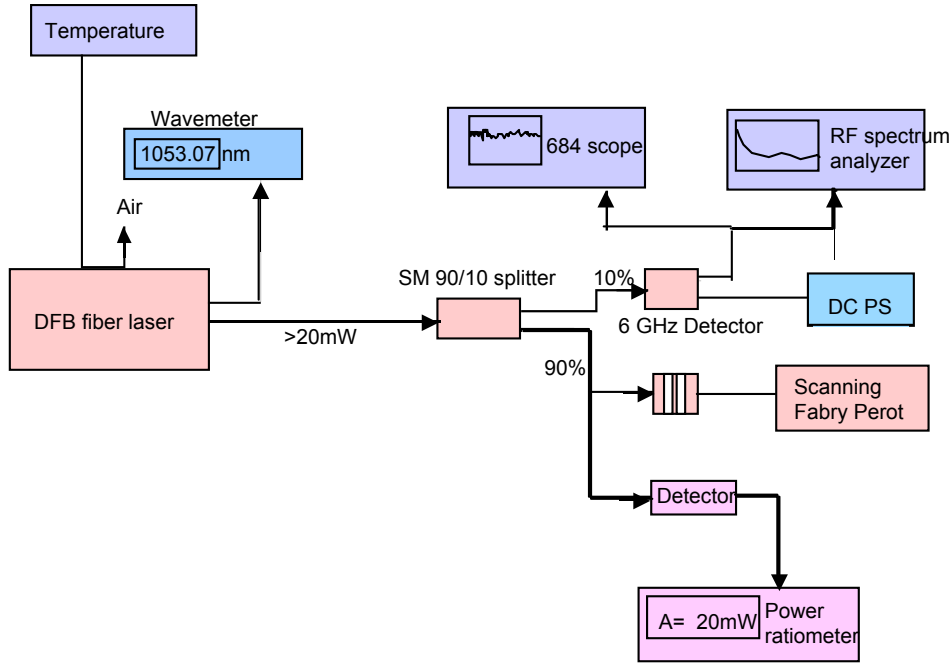

Figure 5 Fiber Oscillator characterization tests layout.

Typical results of tests performed on several production chassis show robust single longitudinal mode operation with no beat moding observed. Peak to peak wavelength stability is an order of magnitude better than the NIF requirement of $\pm 0.01\text{nm}$. Power stability meets the specifications of average output power variation $< 2\%$ RMS (8 hours), and instantaneous output power variation $< 1\%$ p-p (8 hours). The laser pump power to output power slope efficiency is $> 25\%$. Figure 6 shows a graph of laser output power vs pump power in milliwatts.

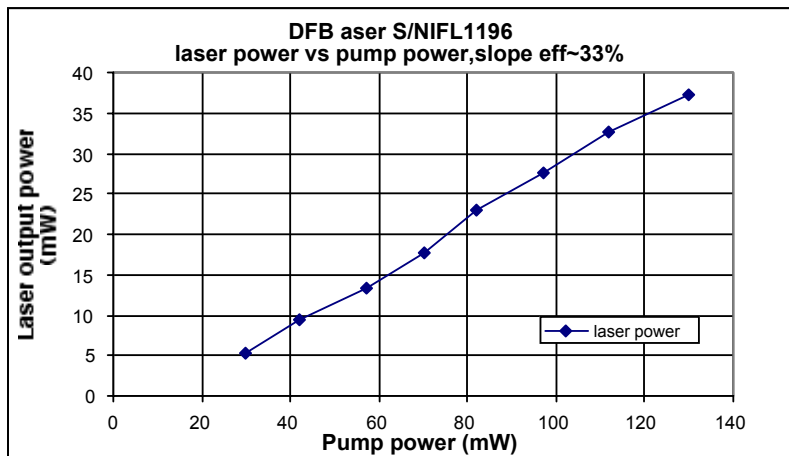

Figure 6: laser power vs pump power, slope efficiency $\sim 33\%$

Scanning Fabry-Perot measurements show robust singlemode operation with no evidence of multimode operation.

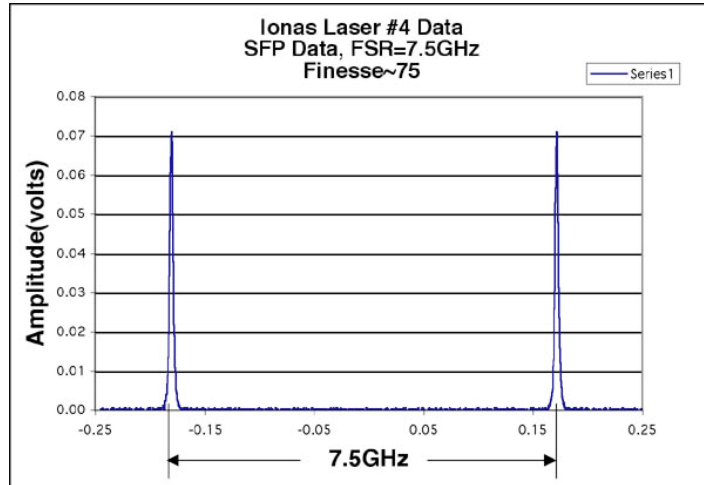

Figure 7: Scanning Fabry Perot Interferometer shows singlemode operation, 7.5Ghz Free Spectral Range

Measurements of instantaneous output power variations are made using a DC to 1Ghz photo detector and fast oscilloscope. Both DC and AC coupled measurements are made to characterize the laser output. The next two graphs show examples of measurements made on a production laser with no evidence of laser relax oscillation spiking. The peak-to-peak noise stability is <math><0.36\%</math>.

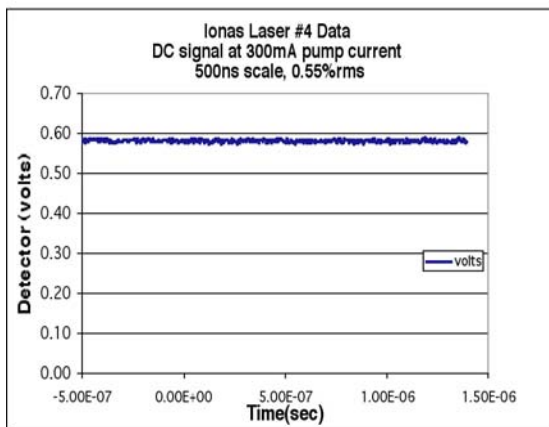
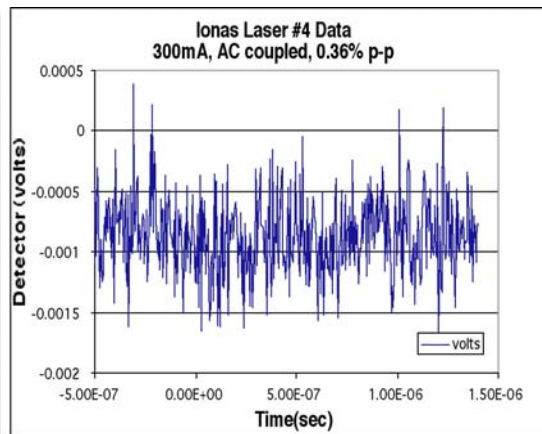

Figure 8 DC measurement of laser output, ~580mV signal, Stability~0.55%rms



AC measurement of laser output, 0.36%p-p



The operational lifetime of the NIF is 30 years. Three production Lasers have been operating in systems 24 hours a day, seven days a week for over two years with no failures. Long-term performance of the lasers has been outstanding. Based on operational experience, required maintenance to the laser chassis has been limited to a few periodic adjustments to the polarization controller. The pump diode will require replacement every 20,000 to 30,000 hours of continuous operation depending on operating current level.

The CW output signal from the oscillator is chopped to 100ns pulses at 1kHz rate for before amplification and injection into the fiber laser system. This energy is continuously monitored by the controls system. The next plot (figure 9) shows 100ns pulse energy vs time with over 5000 hours of operation. The variation of pulse energy is ~10% over the ~8 months of operation.

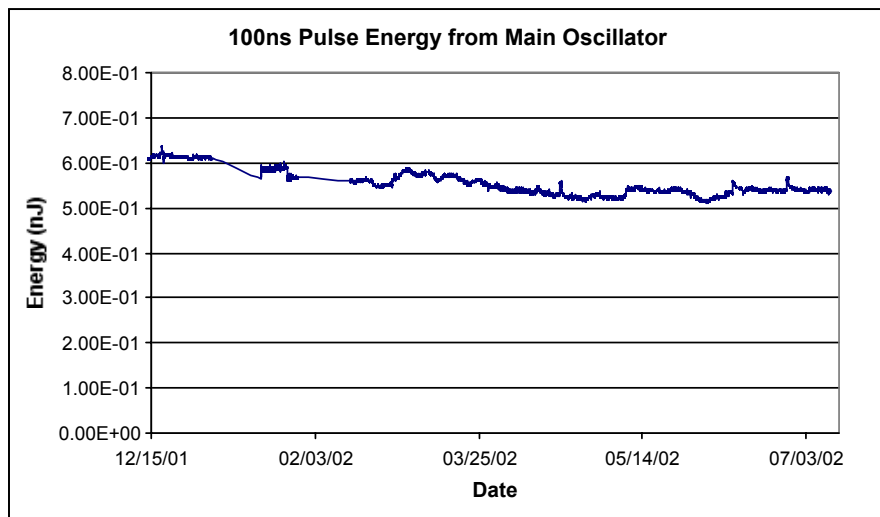

Figure 9 Oscillator pulse energy vs time, ~5000 hours of continuous operation is plotted

In Figure 10 the laser wavelength vs time is plotted over a ~ 3 month operating period. The wavelength stability is about an order of magnitude better than the NIF specification of $\pm 0.01\text{nm}$.

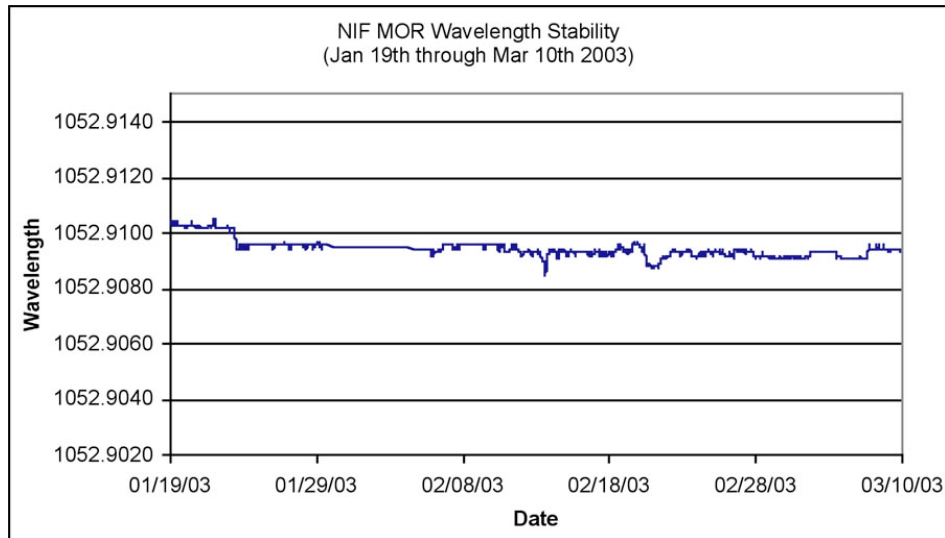

Figure 10 Oscillator wavelength vs time over 3 month period

Summary:

A custom Distributed Feedback Fiber laser operating at 1053nm has been developed for the National Ignition Facility by the company Koheras A/S. The laser provides the seed for the large Fusion Facility and has demonstrated operating characteristics that meet the critical NIF requirements for power and wavelength stability.

The commercial laser circuits are integrated into a custom LLNL chassis design that includes special fiber management, and support electronics for temperature control and monitoring. A series of characterization tests are performed to qualify each Oscillator chassis before integration with the Master Oscillator System. Several Oscillator chassis have been deployed as part of the NIF laser commissioning and operate 24hrs, 7days a week with no failures to date.